

Fire Pit

Glass Wind Guard

www.alaulm.com

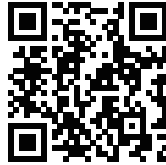



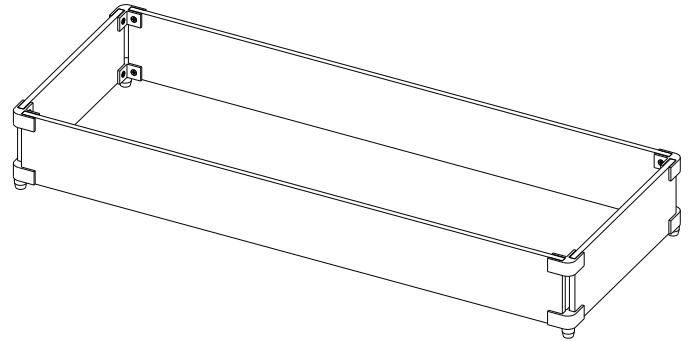

Make Your Life Better.

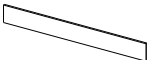

Instructions



Paking Lists

Part	Img	Part Name	Qty
A		Short Glass	2 PCS
B		Long Glass	2 PCS
C		Top Corner Connector	4 PCS
D		Bottom Corner Connector	4 PCS
E		M8 x 10	16 PCS
F		M4 x 13	4 PCS
G		Leg	4 PCS
H		Hand Screw Driver	1 PCS

Step1:Connect A and B with C

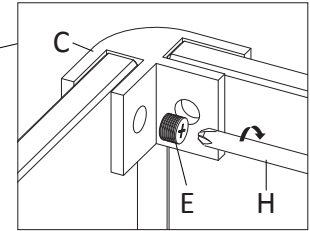
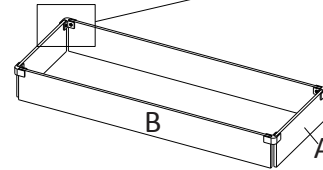

Tips:Do Not 100% Tight

Step2:Connect A and B with D

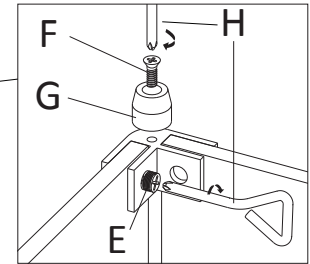
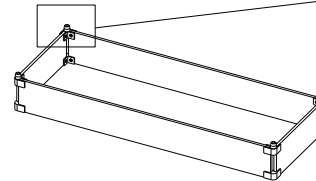

Tips:Do Not 100% Tight

Step3:Put the Glass Wind Guard on the Fire Pit Carefully

