

# **W 118xD 118xH 70 Inch Large Square Pet Run**

## **Assembly instructions**

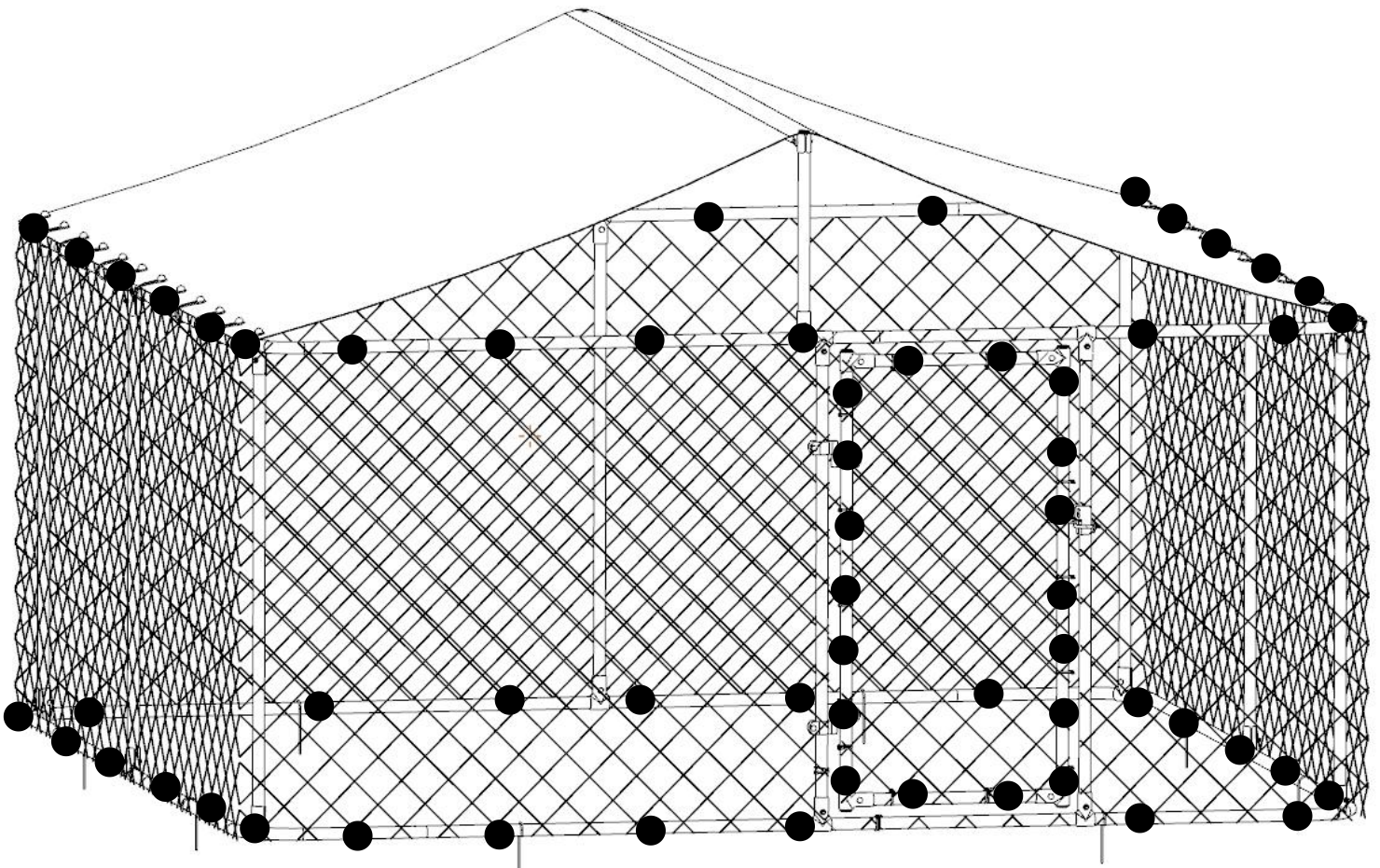

**1.Assembly Time: About 2 Hours ( 2 people together )**



















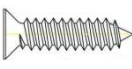

**2.Black spots are places where cable ties are fastened or fastened by iron wires.**

**3.It is recommended to prepare the following tools, which will improve the efficiency of assembly: Adjustable wrench , hammer , pincers , gloves , tape measure,Electric screwdriver.**

# Large Square Pet Run FLF-20DK9.8ft

## W 118xD 118xH 70 Inch

### PART LIST

PART NO.	DIMENSION	STYLE PIC	QUANTITY
DT1	51.2x19.7 inch		8
DT2	52 inch		8
DT3	47.2 inch		11
DT4	19.7 inch		4
DT5	39.4 inch		1
DT6	39.4 inch		2
DK	Big Mesh		1
DL	Door Mesh		1
DM	Rain Cover		1
N	Elastic Rope		26
A	T-Clamps		52
B	M8 Screws-Long		26 sets
O	M8 Screws-Short		4 sets
C	Self-tapping Screws		52
D	Ground Nail		8
E	Door Hinge		2
F	Hinge Lock		1
G	Plastic plug		6
H	Iron Wire		50
I	Cable Tie		250
J	Rubber sleeve		208
P	Wrench		1

# Large Square Pet Run FLF-20DK9.8ft

## W 118xD 118xH 70 Inch

**Attention: Before assembling this cage, please put on gloves and insert the all mesh wire into the rubber sleeves. That can protect you from harm.**

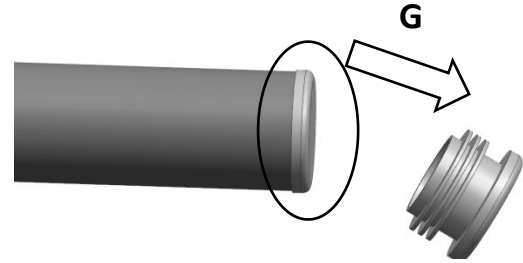
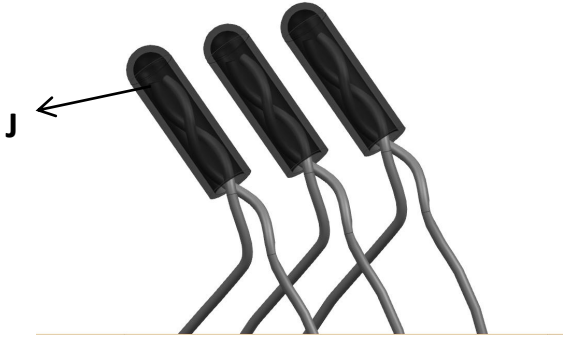

Before assembly, remove the plastic plug from steel pipe

STEP 1

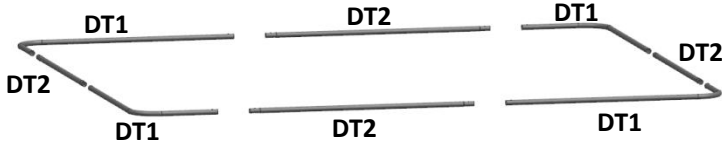

STEP 2

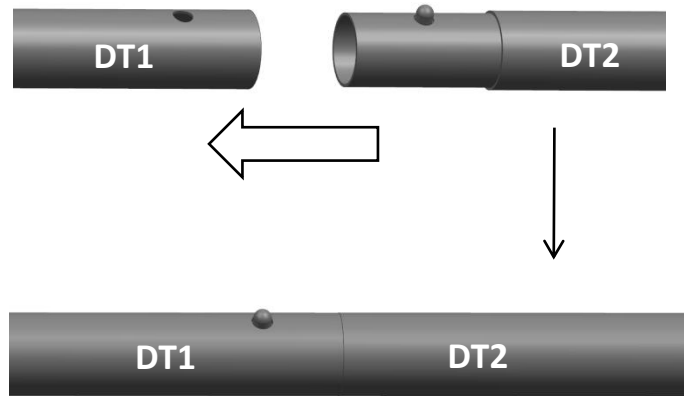

STEP 3

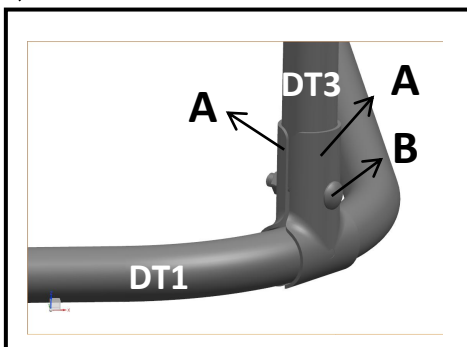
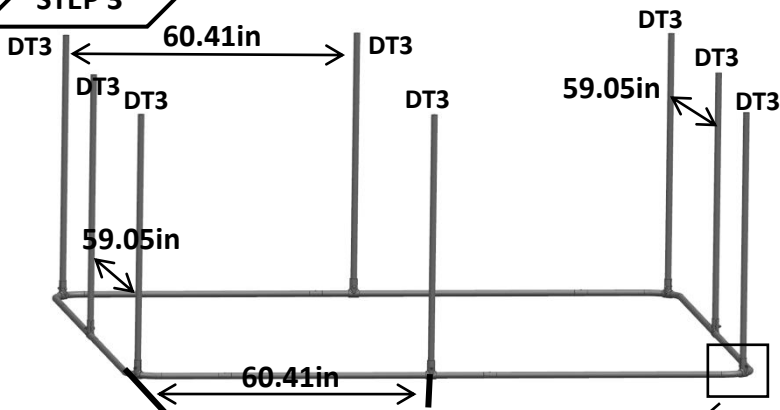

STEP 4

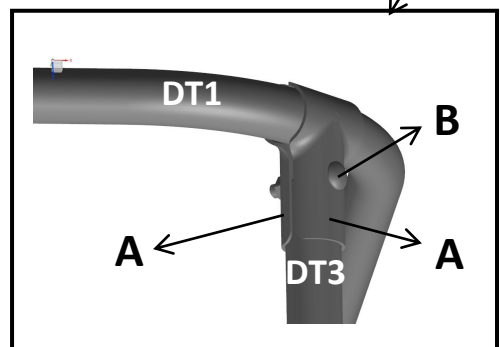
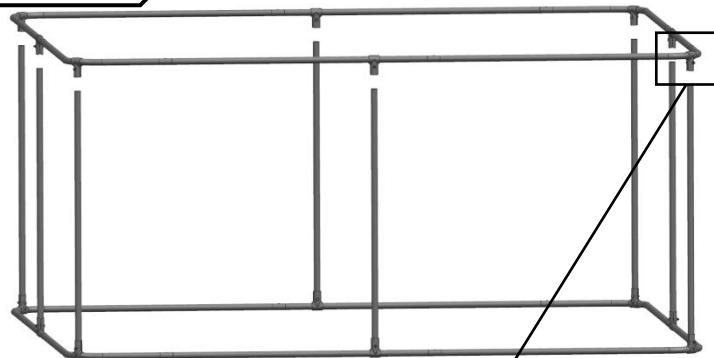

# Large Square Pet Run FLF-20DK9.8ft

W 118xD 118xH 70 Inch

STEP 5

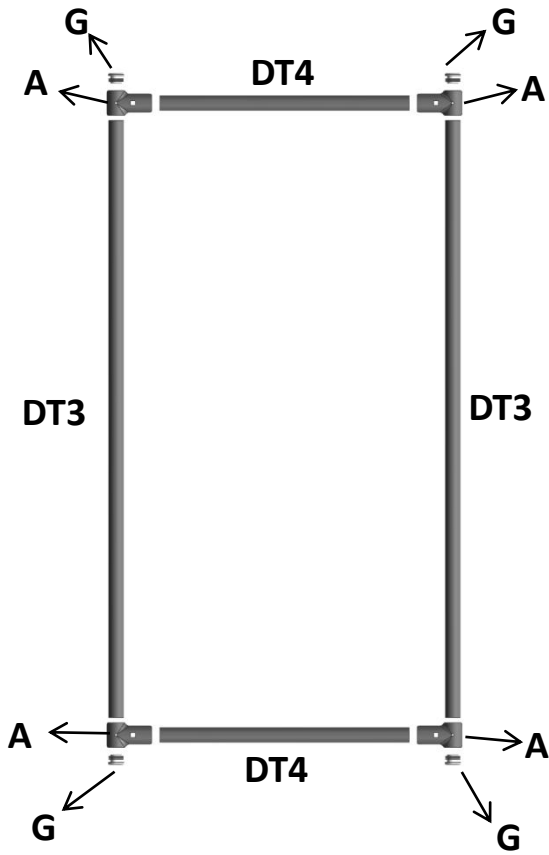

STEP 6

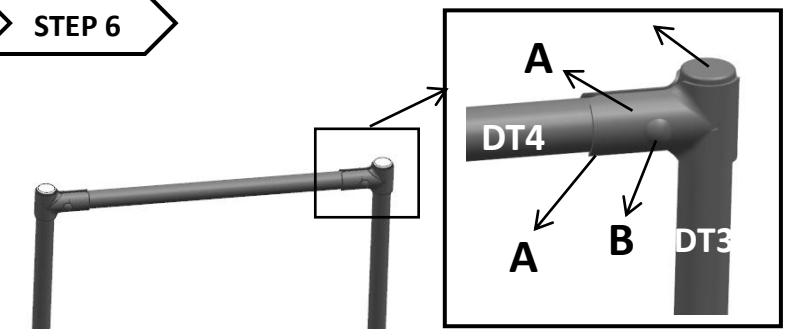

STEP 7

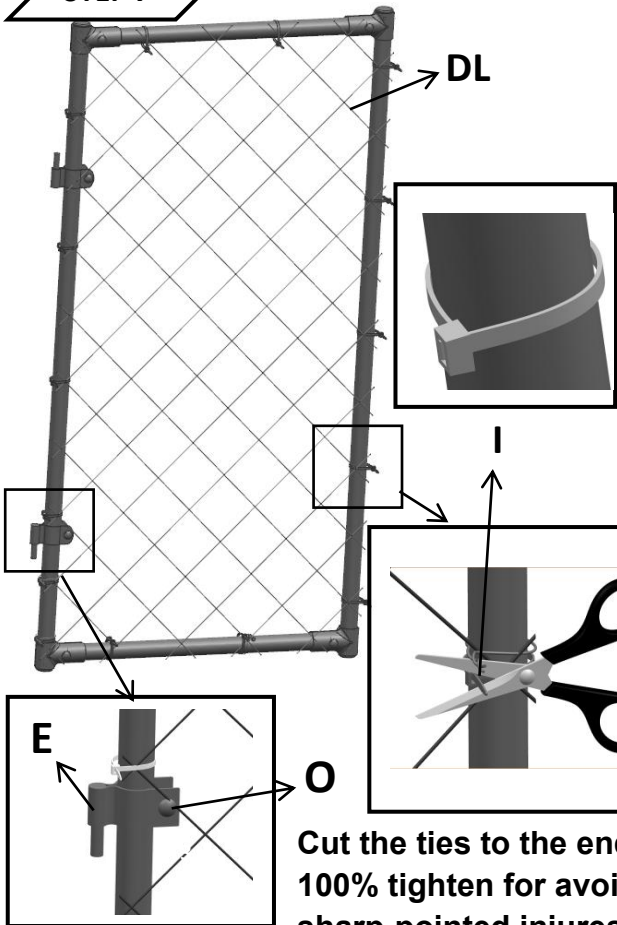

Cut the ties to the end after 100% tighten for avoiding the sharp-pointed injures people or Pet.  
Page 4

STEP 8

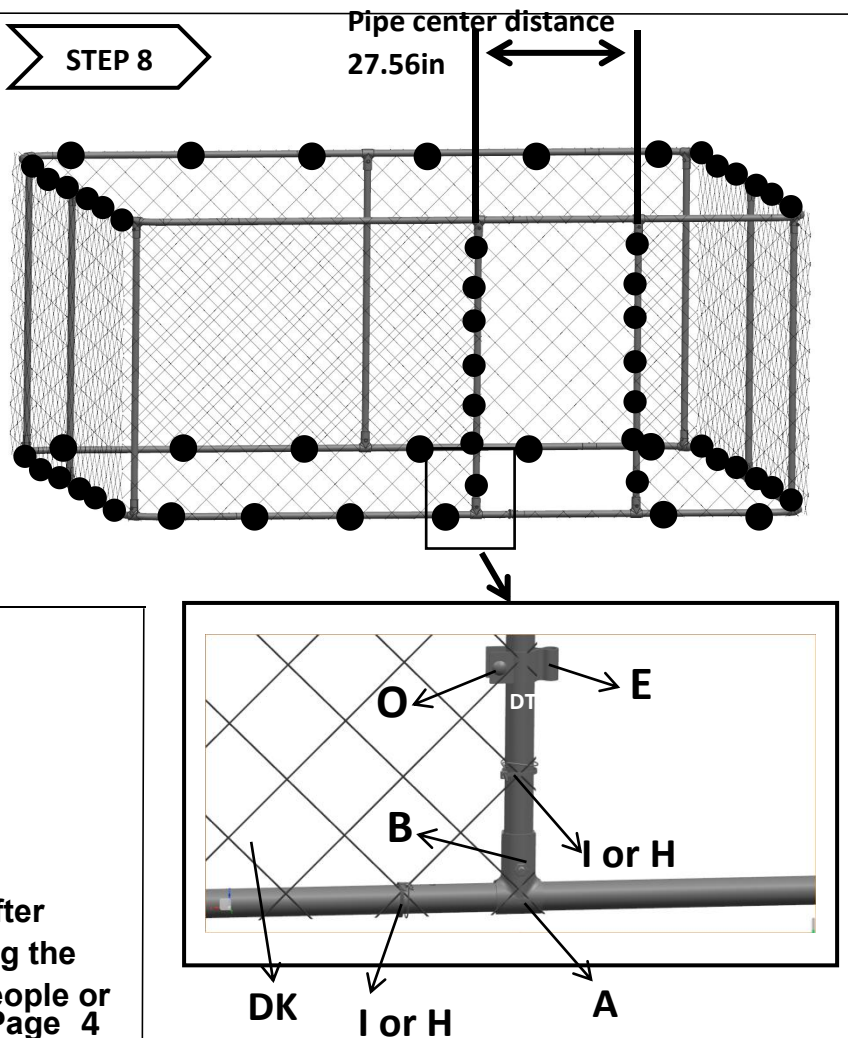

# Large Square Pet Run FLF-20DK9.8ft

W 118xD 118xH 70 Inch

## STEP 9

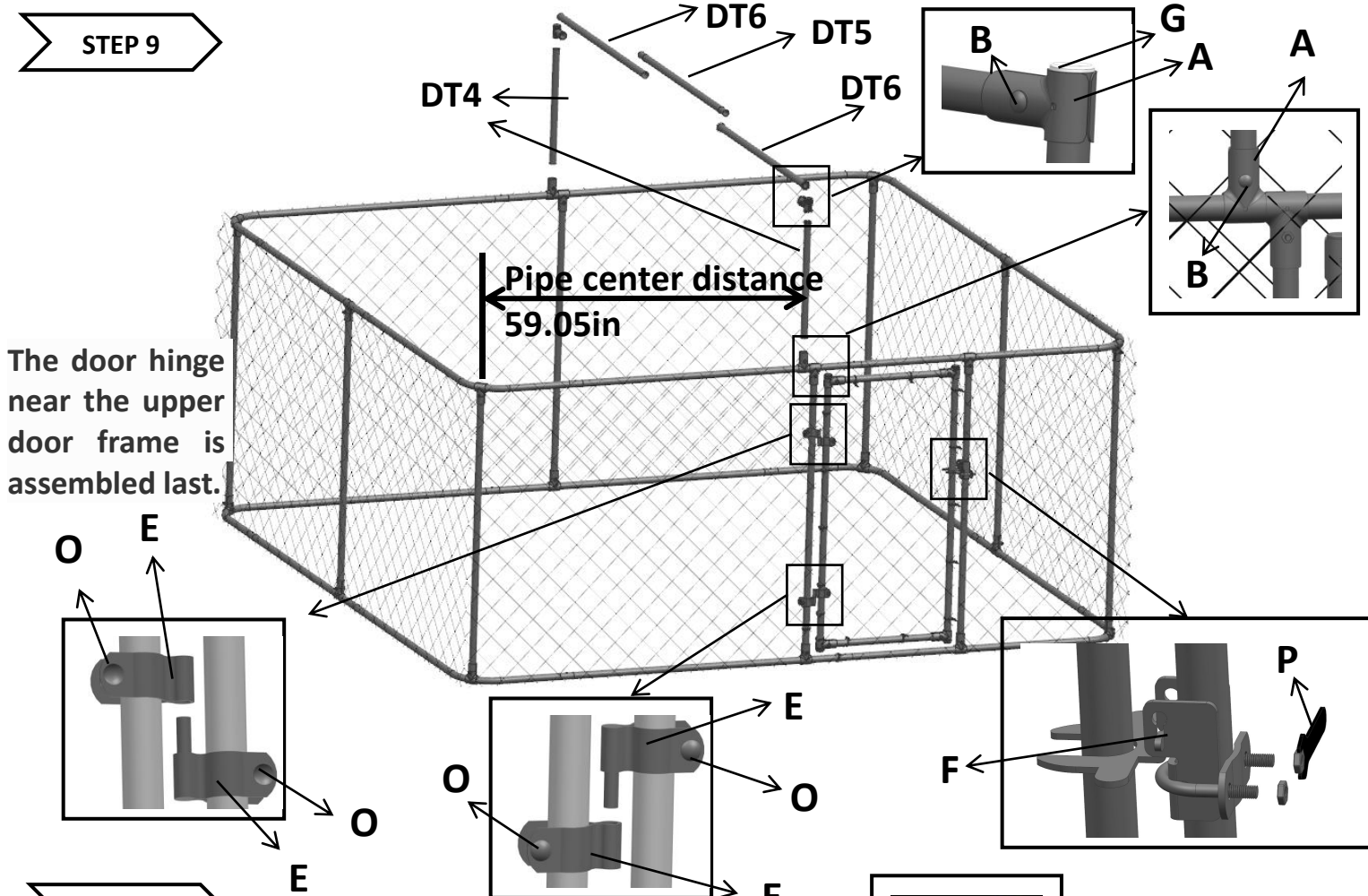

The door hinge near the upper door frame is assembled last.

## STEP 10

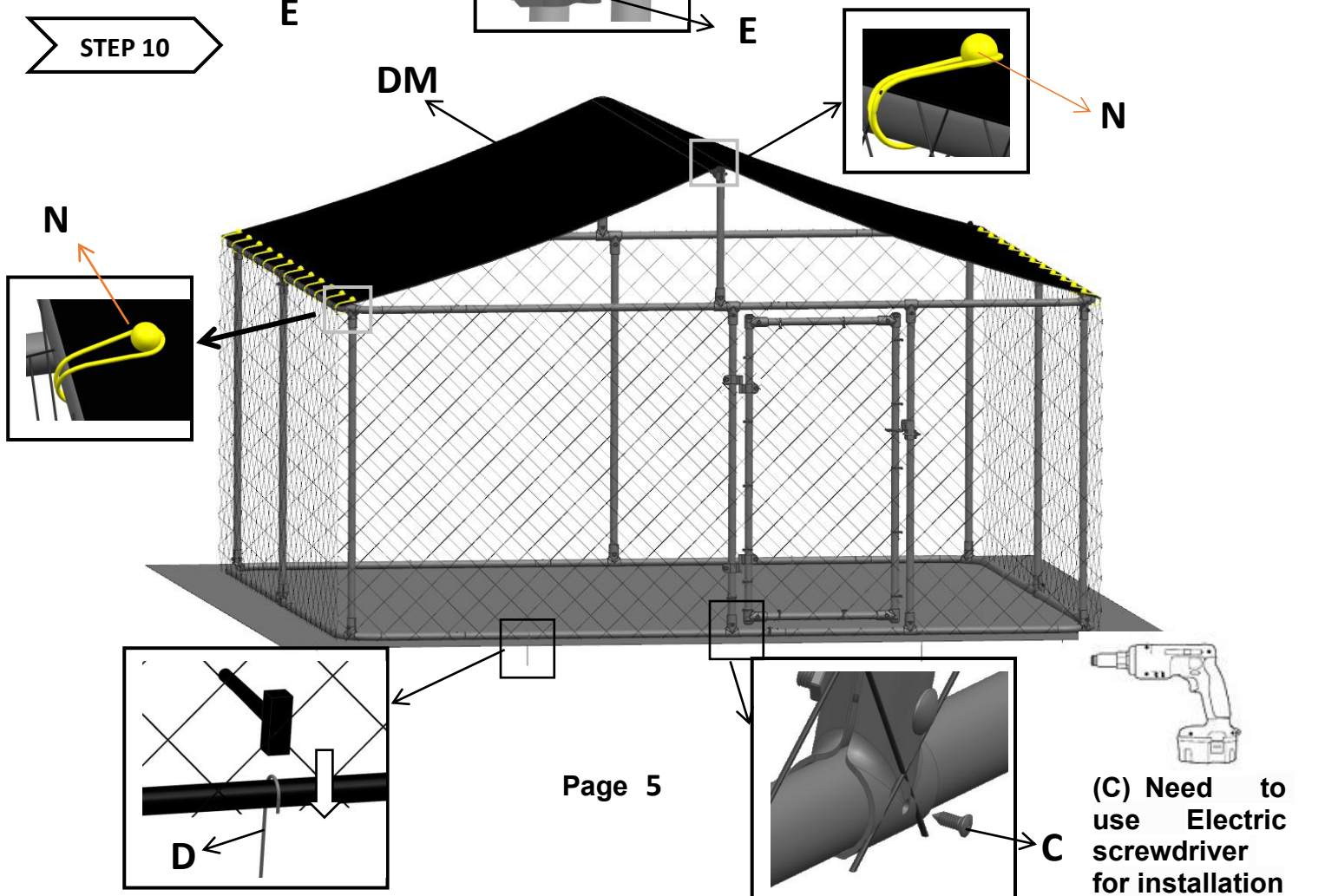

(C) Need to use Electric screwdriver for installation